



# Technics®

## Active subwoofer system

### Operating Instructions

Before connecting, operating or adjusting this product, please read these instructions completely.  
Please keep this manual for future reference.

Model No. **SB-AS100**

#### Dear customer

Thank you for purchasing this product.  
For optimum performance and safety, please read these instructions carefully.

#### User memo:

DATE OF PURCHASE _____
DEALER NAME _____
DEALER ADDRESS _____
TELEPHONE NUMBER _____

The model number and serial number of this product can be found on either the back or the bottom of the unit.  
Please note them in the space provided below and keep for future reference.

MODEL NUMBER	SB-AS100
SERIAL NUMBER	_____

### Supplied accessories

Please check and identify the supplied accessories.  
Use numbers indicated in parentheses when asking for replacement parts.

*(Only for U.S.A.)*

To order accessories contact 1-800-332-5368 or web site (<http://www.panasonic.com>).

Monaural connection cable (RJL1P015B50) ..... 1pc.



AC power supply cord (RJA0065-K) ..... 1pc.



#### Note

The included AC power supply cord is for use with this unit only.  
Do not use it with other equipment.

Speaker feet (RFA0631A-K) ..... 1sheet (4 feet)  
Replacements sold in 1-sheet lots (4 feet per sheet).



### Technical specifications

#### ■ SPEAKER SECTION

Type	1 way 2 speaker system Bass-reflex type
Speaker	
Woofer	14 cm(5-1/2") cone type × 2
Impedance	1 Ω
Input power	
Music	200 W
DIN	100 W
Sound pressure level	82 dB/W (1.0 m)
Frequency range	40 – 380 Hz (at –16 dB) 45 – 310 Hz (at –10 dB)

#### ■ AMPLIFIER SECTION

Continuous power output	100 W (1 Ω)
20–200 Hz (THD 1%)	
Phase switching	NORMAL/REVERSE
Input sensitivity/Impedance	335 mV/15 kΩ
Low pass filter	50–200 Hz Variable

#### ■ GENERAL

Power supply	AC 120 V, 60 Hz
Power consumption	40 W
Dimensions (W × H × D)	(231 × 450 × 350) mm (9-3/32" × 17-23/32" × 13-25/32")
Mass	9.0 kg(19.8 lb.)

#### Note

Specifications are subject to change without notice.  
Mass and dimensions are approximate.

#### Product service

Do not attempt to remove the cover(s) or repair the unit yourself.  
Refer servicing to qualified personnel only.

#### Product information

For product service, product information or assistance with product operation, refer to the servicenter directory.

**For detailed instructions, contact an authorized servicenter in the U.S.A. and Panasonic Canada Inc. Customer Care Centre in Canada.**

**In the U.S.A. 1-800-211-7262 or web site (<http://www.panasonic.com>)**

**In Canada 905-624-5505 or web site ([www.panasonic.ca](http://www.panasonic.ca))**

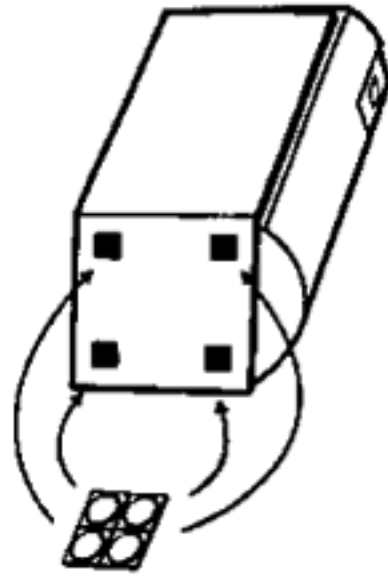
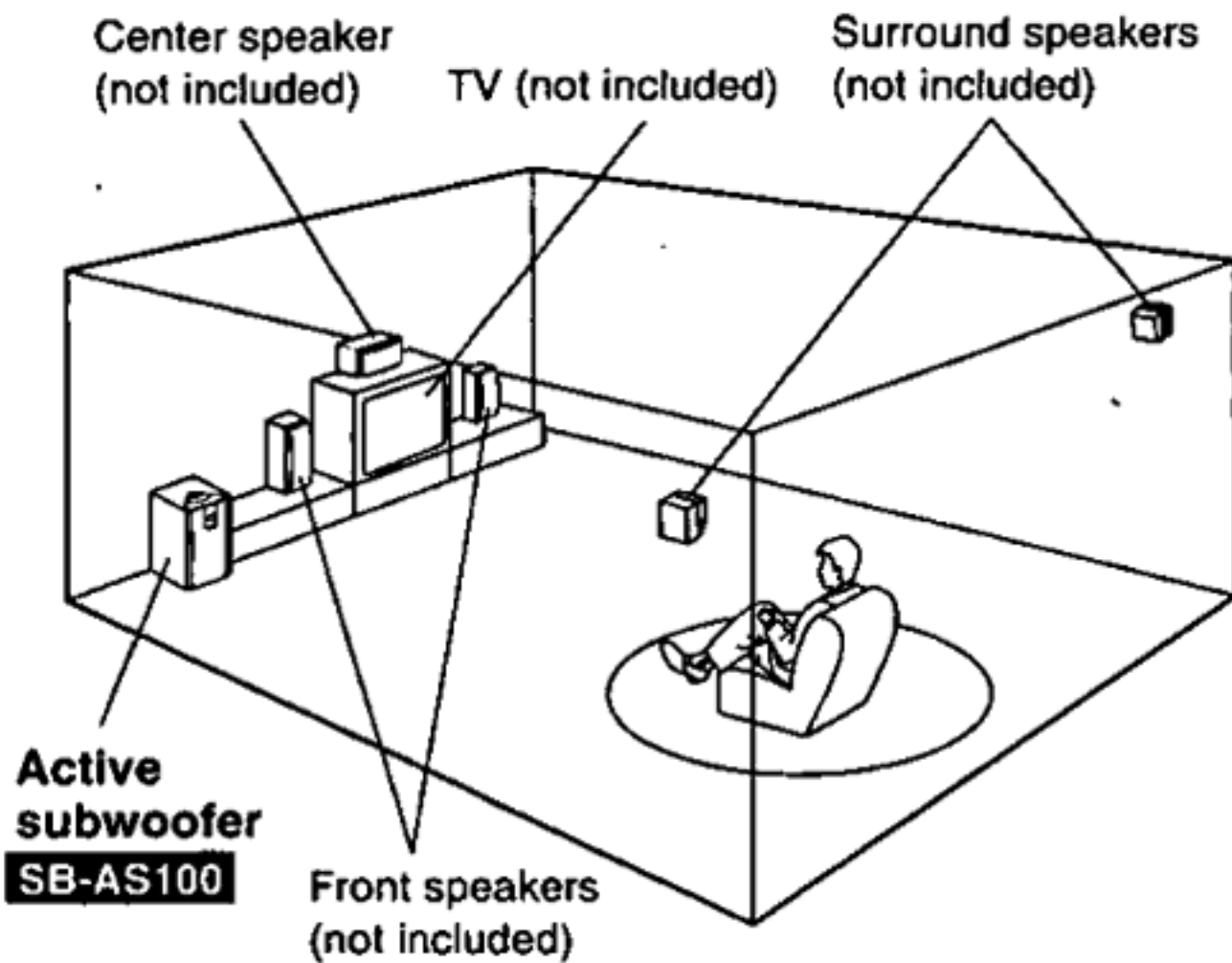
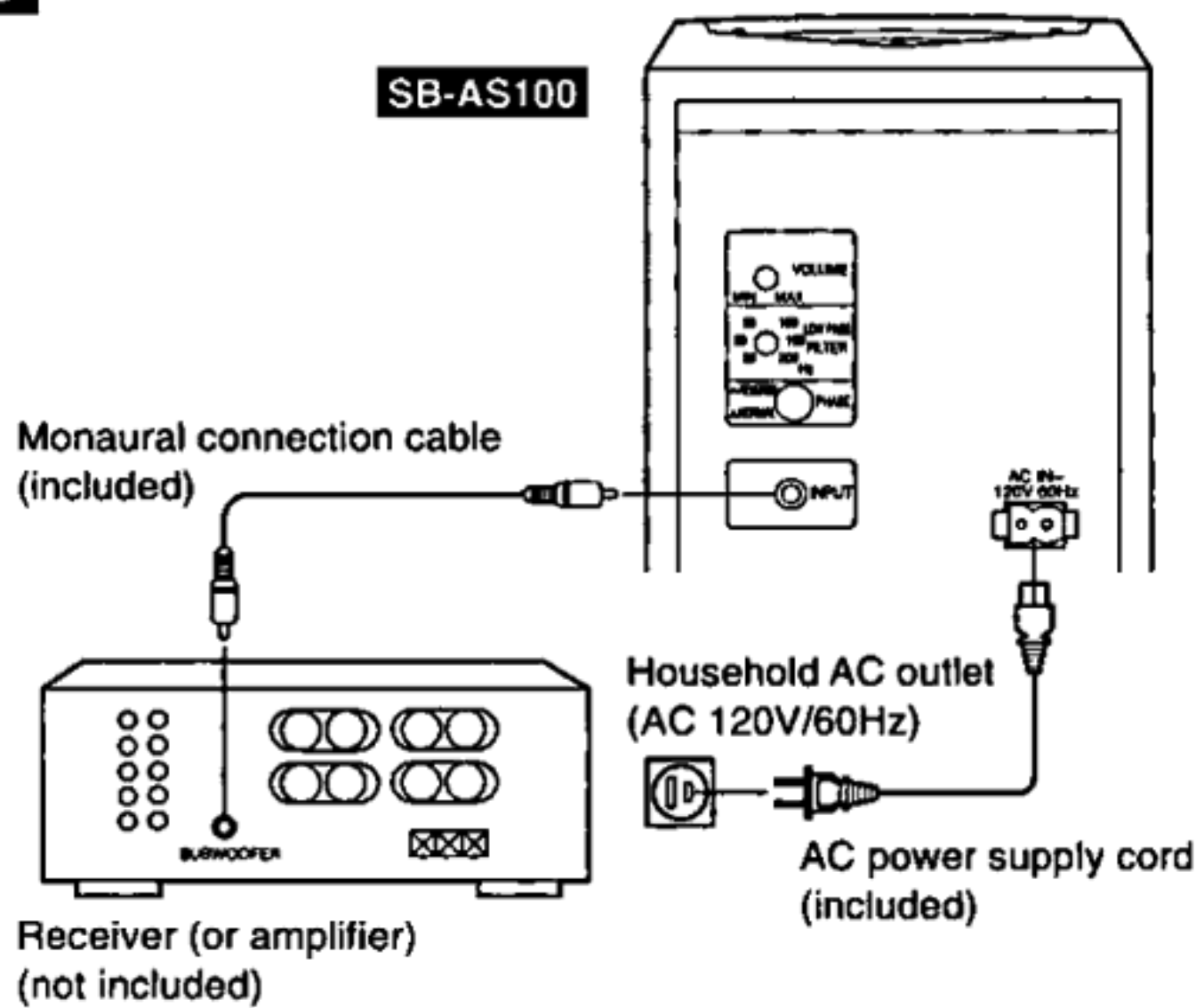
**A****B****C**

## Positioning the speaker

**A Attach the rubber feet (included) to the speaker**  
Attach these rubber feet to prevent vibration causing the speaker to move or fall over.

**B The diagram shows the basic positioning of each speaker.**

- The subwoofer can be placed in any position as long as it is at a reasonable distance from the TV.
- Do not place any object on top of this unit.

**If irregular coloring occurs on your television**  
this speaker is designed to be used close to a television, but the picture may be affected with some televisions and set-up combinations.

**If this occurs, turn the television off for about 30 minutes.**  
The television's demagnetizing function should correct the problem. If it persists, move the speaker further away from the television.

**Note:**  
Do not attach this speaker to walls or ceilings.

## Protection circuitry

This unit incorporates speaker-protection circuits to prevent damage caused by excessive input or abnormal signals. When excess input is detected, the input is automatically interrupted.

**■ If sound is interrupted...**

1. Reduce the volume level from the receiver or amplifier.
2. Check whether or not there is anything wrong with the equipment used such as the sound source, or connections. If there is nothing wrong, turn off the power.
3. Turn on the power once again.

**■ After the protection circuitry is reset...**

Take care not to increase the receiver's or amplifier's volume level too much.

**Other notes:**

Be sure to reduce the volume on the receiver (or amplifier) when the signal input exceeds the rated allowable input to avoid damage to circuitry or other malfunctions.

## Connections

### Connecting to receiver (or amplifier)

**Note:**

- Can be connected to a receiver (or amplifier) with a pin cord type subwoofer terminal.
- Before making the connections, switch OFF the power to the receiver (or amplifier).

### Power connections

Connect AC power supply cord after all other cables and cords are connected.

## Note

1. Avoid placing in areas as follows:
  - In direct sunlight
  - Near heating appliances or other sources of heat
  - Where there is high humidity
2. Never use alcohol, paint thinner, benzene or similar chemicals to clean the unit, as they may damage the finish.



## Operation

Set the low pass filter, volume and phase to suit characteristics of the speaker and SB-AS100 combination.

### 1 Set [POWER] to the " ON" position.

The unit is now in standby mode and the POWER indicator turns red.

When a signal is received the unit turns ON automatically and the indicator turns green.

The unit automatically switches to standby if a signal is not received for approximately two (2) minutes

### 2 Set [LOW PASS FILTER] to a suitable frequency. Refer to "Frequency response by LOW PASS FILTER setting".

### 3 Set [VOLUME] to a suitable level. Refer to "Frequency response by VOLUME setting".

### 4 After playing some music, set [PHASE] to " NORMAL" or " REVERSE", whichever position allows playback to sound normal.

For your reference:

If subwoofer and front speaker phase are the inverse of one another, they will tend to cancel each other out. Playback will not be normal and sounds will seem muffled.

#### When settings are complete

The only operation you should have to perform daily is press [POWER] to turn the unit ON/OFF.

If you reposition the system and the acoustics change, reset the unit as necessary.

#### Note

If the volume output is too loud, this unit's amplifier can be clipped, causing output to sound unusual. Reduce the volume of the receiver or amplifier or the volume of this unit if this occurs.

#### CAUTION:

This equipment has been tested and found to comply with the limits for a Class B digital device, pursuant to Part 15 of the FCC Rules.

These limits are designed to provide reasonable protection against harmful interference in a residential installation. This equipment generates, uses and can radiate radio frequency energy and, if not installed and used in accordance with the instructions, may cause harmful interference to radio communications. However, there is no guarantee that interference will not occur in a particular installation. If this equipment does cause harmful interference to radio or television reception, which can be determined by turning the equipment off and on, the user is encouraged to try to correct the interference by one of the following measures:

- Reorient or relocate the receiving antenna.
- Increase the separation between the equipment and receiver.
- Connect the equipment into an outlet on a circuit different from that to which the receiver is connected.
- Consult the dealer or an experienced radio/TV technician for help.

Any unauthorized changes or modifications to this equipment would void the user's authority to operate this device.

This device complies with Part 15 of the FCC Rules. Operation is subject to the following two conditions: (1) This device may not cause harmful interference, and (2) this device must accept any interference received, including interference that may cause undesired operation.

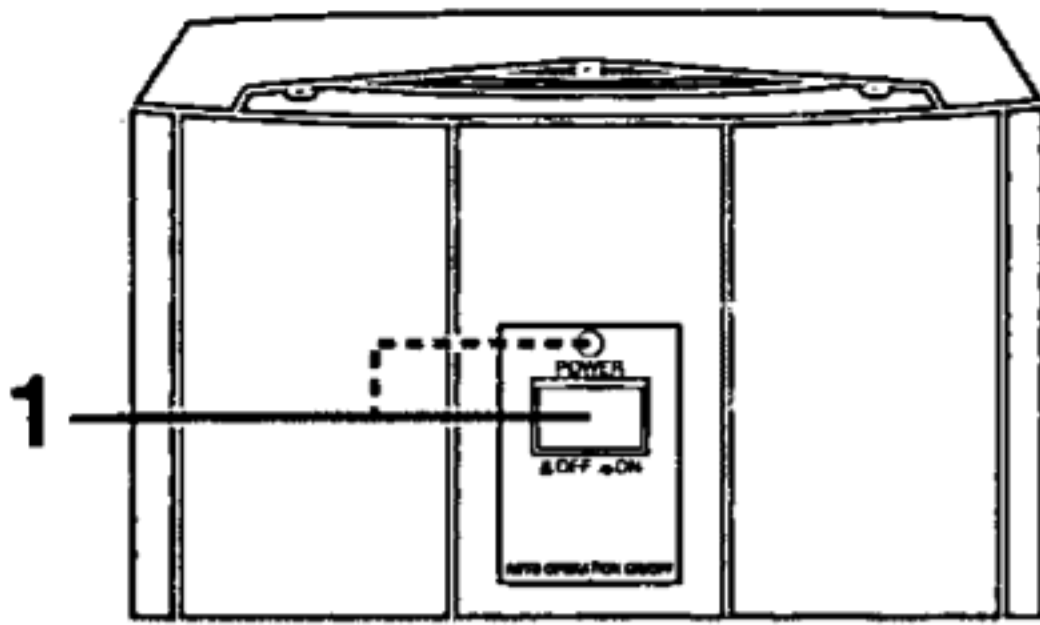

Front

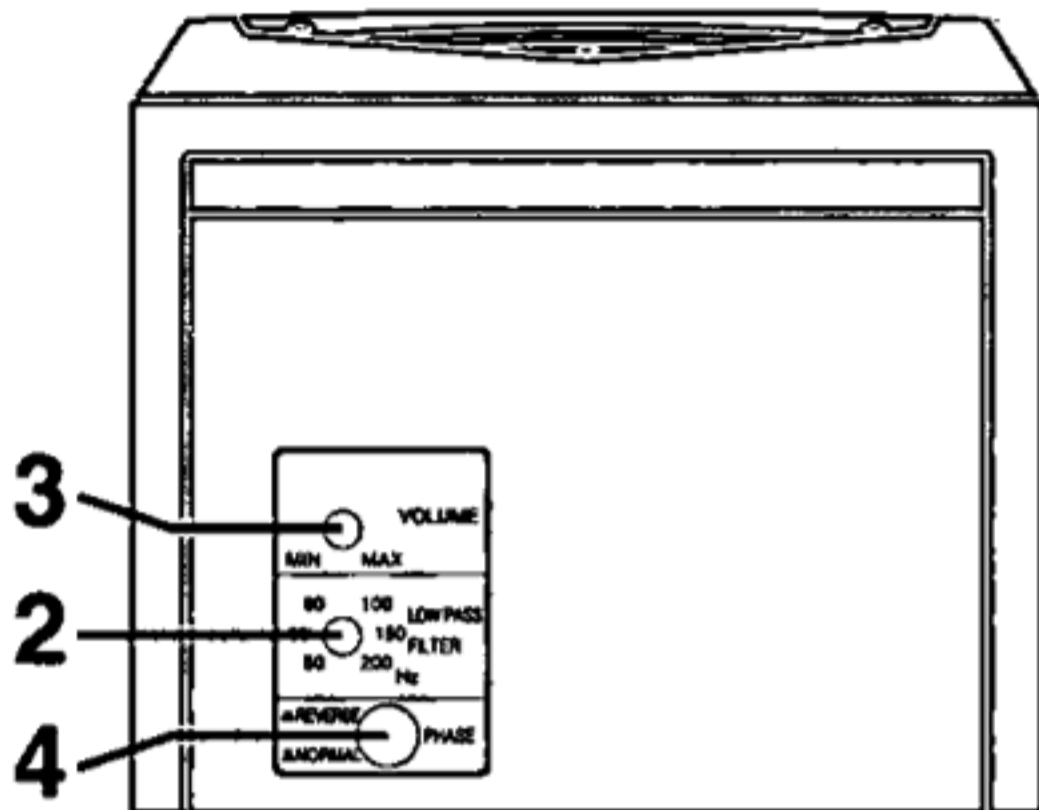

Rear

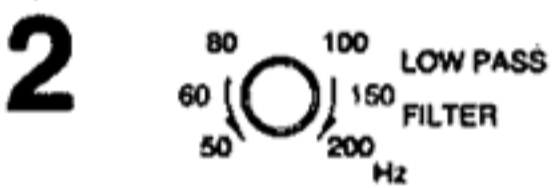

Frequency response by LOW PASS FILTER setting

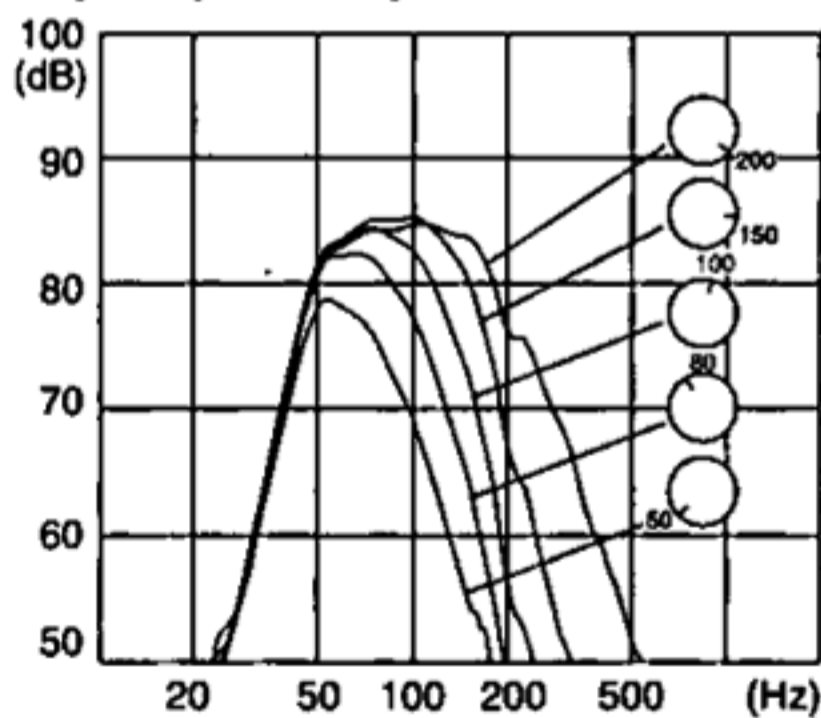

Frequency response by VOLUME setting

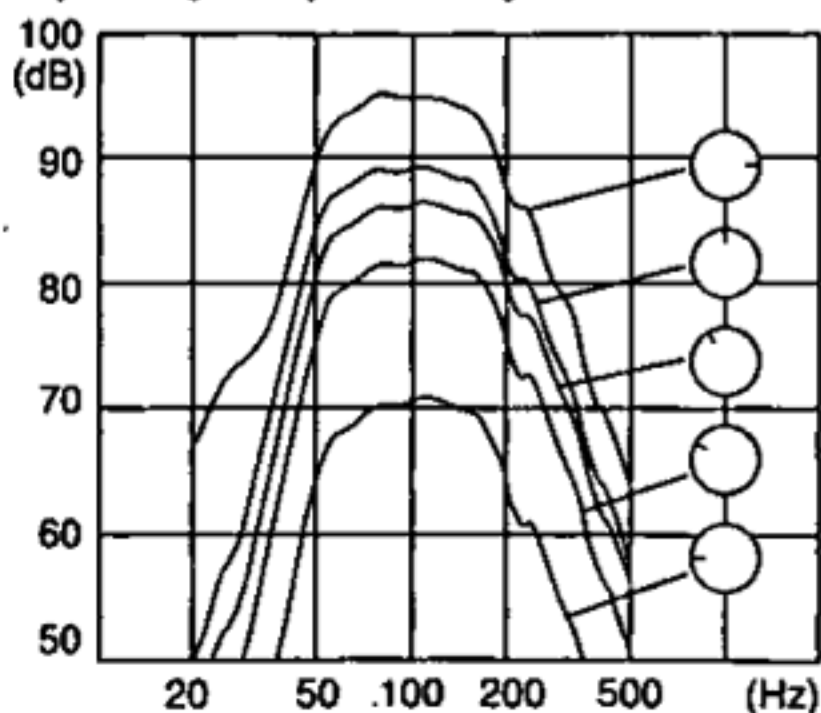

## WARNING:

TO REDUCE THE RISK OF FIRE, ELECTRIC SHOCK OR PRODUCT DAMAGE, DO NOT EXPOSE THIS APPLIANCE TO RAIN, SPLASHING, DRIPPING OR MOISTURE.



CAUTION: TO REDUCE THE RISK OF ELECTRIC SHOCK, DO NOT REMOVE SCREWS. NO USER-SERVICEABLE PARTS INSIDE. REFER SERVICING TO QUALIFIED SERVICE PERSONNEL.



The lightning flash with arrowhead symbol, within an equilateral triangle, is intended to alert the user to the presence of uninsulated "dangerous voltage" within the product's enclosure that may be of sufficient magnitude to constitute a risk of electric shock to persons.



The exclamation point within an equilateral triangle is intended to alert the user to the presence of important operating and maintenance (servicing) instructions in the literature accompanying the appliance.

## Precautions

Before using this unit please read these operating instructions carefully. Take special care to follow the warnings indicated on the unit itself as well as the safety suggestions listed below. Afterwards keep them handy for future reference.

## Safety

- Power Source**—The unit should be connected to power supply only of the type described in the operating instructions or as marked on the unit.
- Polarization**—If the unit is equipped with a polarized AC power plug (a plug having one blade wider than the other), that plug will fit into the AC outlet only one way. This is a safety feature. If you are unable to insert the plug fully into the outlet, try reversing the plug. If the plug should still fail to fit, contact your electrician to replace your obsolete outlet. Do not defeat the safety purpose of the polarized plug.
- Power Cord Protection**—AC power supply cords should be routed so that they are not likely to be walked on or pinched by items placed upon or against them. Never take hold of the plug or cord if your hand is wet, and always grasp the plug body when connecting or disconnecting it.
- Nonuse Periods**—When the unit is not used, turn the power off. When left unused for a long period of time, the unit should be unplugged from the household AC outlet.

## Installation

### Environment

- Water and Moisture**—Do not use this unit near water—for example, near a bathtub, washbowl, swimming pool, or the like. Damp basements should also be avoided.
- Heat**—The unit should be situated away from heat sources such as radiators and the like. It also should not be placed in temperatures less than 5°C (41°F) or greater than 35°C (95°F).

### Placement

- Ventilation**—The unit should be situated so that its location or position does not interfere with its proper ventilation. Allow 10 cm (4") clearance from the rear of the unit.
- Foreign Material**—Care should be taken so that objects do not fall into and liquids are not spilled into the unit. Do not subject this unit to excessive smoke, dust; mechanical vibration, or shock.
- Magnetism**—The unit should be situated away from equipment or devices that generate strong magnetic fields.
- Stacking**—Do not place heavy objects, other than system components, on top of the unit.
- Surface**—Place the unit on a flat, level surface.
- Carts and Stands**—The unit should be used only with a cart or stand that is recommended by the manufacturer. The unit and cart combination should be moved with care. Quick stops, excessive force, and uneven surfaces may cause the unit and cart combination to overturn.
- Wall or Ceiling Mounting**—The unit should not be mounted to a wall or ceiling, unless specified in this operating instructions.



## Maintenance

Clean the cabinet, panel and controls with a soft cloth lightly moistened with mild detergent solution. Do not use any type of abrasive pad, scouring powder or solvent such as alcohol or benzene.

## Service

- Damage Requiring Service**—The unit should be serviced by qualified service personnel when:
  - The AC power supply cord or the plug has been damaged; or
  - Objects have fallen or liquid has been spilled into the unit; or
  - The unit has been exposed to rain; or
  - The unit does not appear to operate normally or exhibits a marked change in performance; or
  - The unit has been dropped, or the enclosure damaged.
- Servicing**—The user should not attempt to service the unit beyond that described in the operating instructions. All other servicing should be referred to an authorized service personnel.  
**For the address of an authorized servicer:**  
**In the U.S.A. 1-800-211-7262 or web site**  
**(<http://www.panasonic.com>)**  
**In Canada 905-624-5505 or web site**  
**([www.panasonic.ca](http://www.panasonic.ca))**

Panasonic Consumer Electronics Company, Division of Matsushita Electric Corporation of America  
One Panasonic Way Secaucus, New Jersey 07094  
<http://www.panasonic.com>

Panasonic Sales Company, Division of Matsushita Electric of Puerto Rico, Inc. ("PSC")  
Ave. 65 de Infanteria, Km. 9.5  
San Gabriel Industrial Park, Carolina, Puerto Rico 00985



Matsushita Electric Industrial Co., Ltd. 1999  
Printed in U.S.A.

RQT5460-P  
M1299TK0